

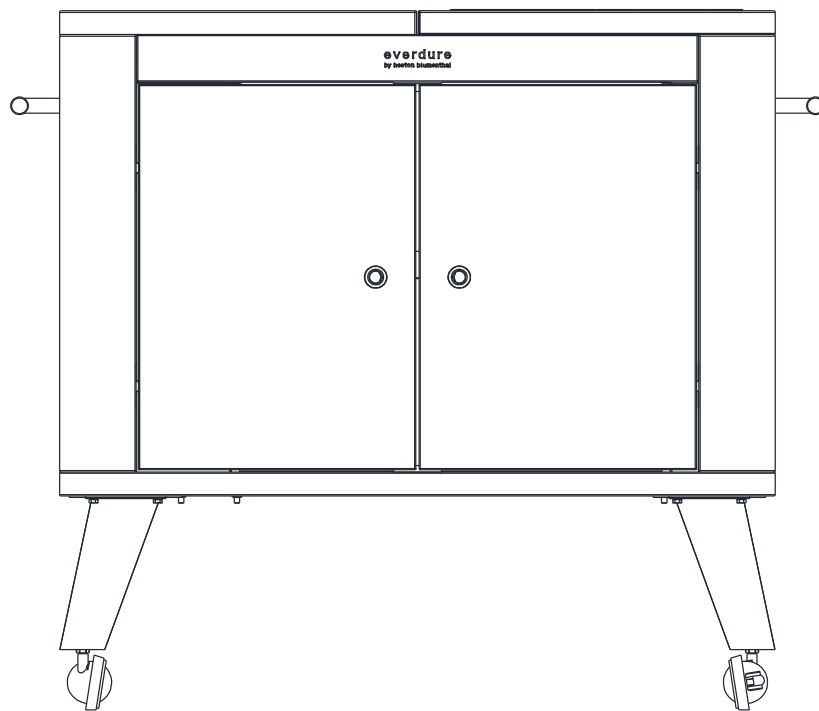

ASSEMBLY & MAINTENANCE INSTRUCTIONS

for everdure by heston blumenthal Prep Kitchen



Model Number:





HBPK

everdure
by heston blumenthal

MAINTENANCE

	Prep Kitchen		
HBKP	LENGTH (in)	WIDTH (in)	HEIGHT (in)
	40.2	21.7	35

CLEANING:



-  Using a soft cloth thoroughly wipe down all surfaces with a mild detergent and warm water
-  **DO NOT** use scourers or harsh detergents
-  **DO NOT** put cutting boards or wooden lids in the dishwasher
-  **DO NOT** put seasoning boxes in a microwave or oven to reheat food

STORAGE:

When the prep kitchen is not in use, it can be stored outdoors, but **MUST** be under cover and covered (preferably with a purpose made cover HBPCKOVERL) out of the weather ensuring the cutting surfaces are clean before storing away.

NOTE: These instructions are also available at www.everdurebyheston.com/international







PACKAGING:

-  Remove all external packaging and remove the Prep Kitchen from the packaging before use
-  Removal all internal cartons and packaging from within the Prep Kitchen assembly
-  Recycle as per local government laws

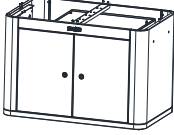
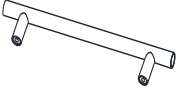
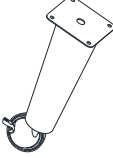
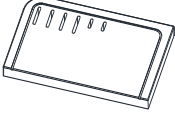
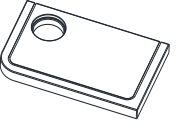

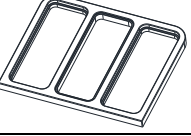
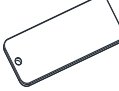
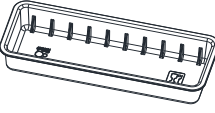

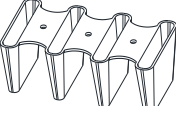

ASSEMBLY

⚠ NOTE: 2 people required for assembly

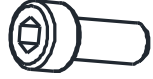
Main Parts

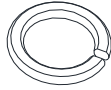
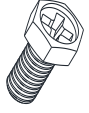
(P1) Body × 1 	(P2) Handle × 2 	(P3) Leg × 4 	(P4) Cutting Board LU × 1pc 
(P5) Cutting Board LB × 1 	(P6) Cover × 1 	(P7) Top Panel × 1 	(P8) Lid × 2 
(P9) Storage Tray × 3 	(P10) Seasoning Box × 4 	(P11) Divider × 1 	(P12) Waste Bin × 1 
(P13) knife holder × 1pc 			

Hardware

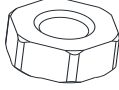
(H1)/ Hex Bolt M8*20mm × 4 	(H2)/ Washer φ 8mm × 4 	(H3)/ Spring Washer φ 8mm × 4 
(H5)/ Hex Bolt M6*12mm × 16 	(H6)/ Washer φ 6mm × 16 	(H7)/ Spring Washer φ 6mm × 16pcs 
(H8)/Self-tapping screw × 3pcs 	(H9)/ Bolt M6 × 3pcs 	(H10)/ Nut M6 × 3pcs 

ASSEMBLY

Step 01

/Rotate (P1) upside-down onto a clean and flat surface, ensuring the body is protected using a sheet or cardboard. Assemble (P3 x 4) to the bottom plate using (H5 x 16, H6 x 16, H7 x 16)
Ensure the legs are angled outwards (see final image for reference) and rotate the body to the upright position.

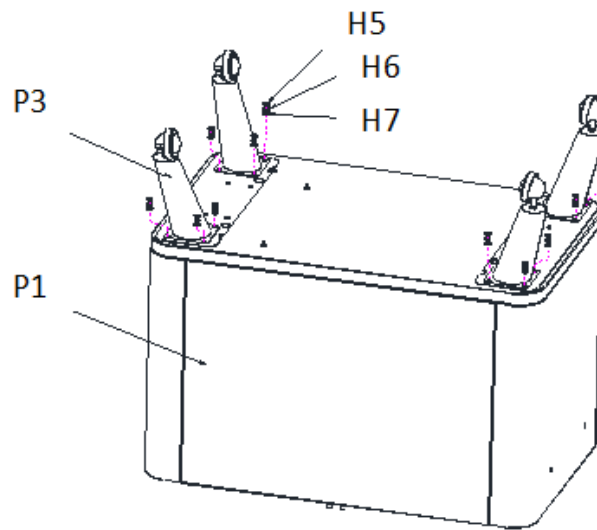

Step 02

/Fix and fully tighten (P2 x 2) onto main body and the side door using (H1 x 4, H2 x 4, H3 x 4).

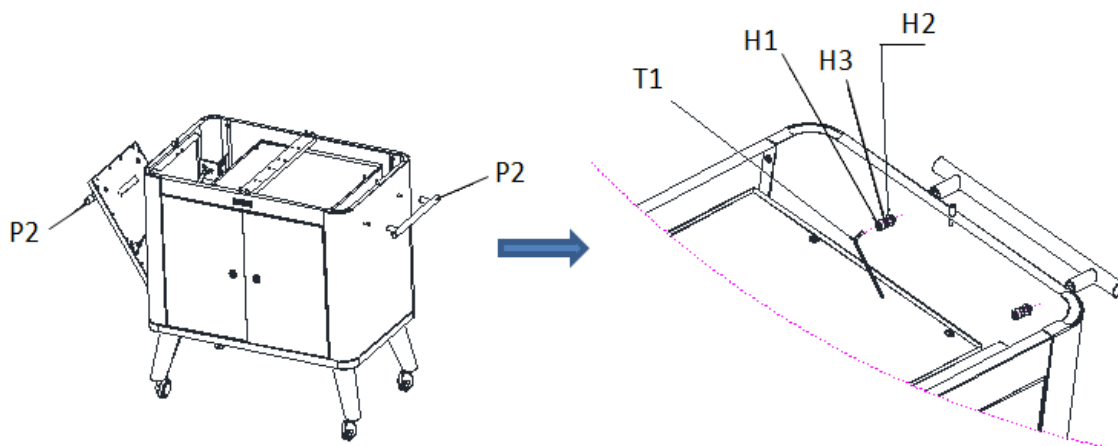

ASSEMBLY

Step 03

/Slide (P11 x 1) into (P12 x 1)

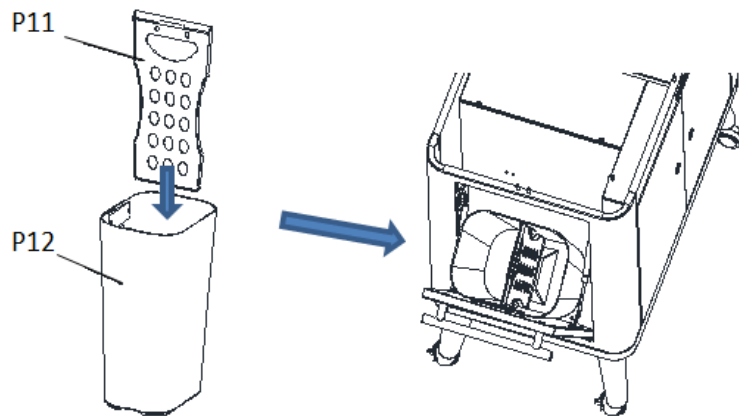

Step 04

/ Assemble (P13 x 1) to the bottom of the Cutting Board LU (P4 x 1) using (H8 x 3).

*Note, please remove the plastic protection from all wooden boards before assembly.

There are 3 reserved small holes at the bottom of the Cutting Board LU, corresponding to the installation screws

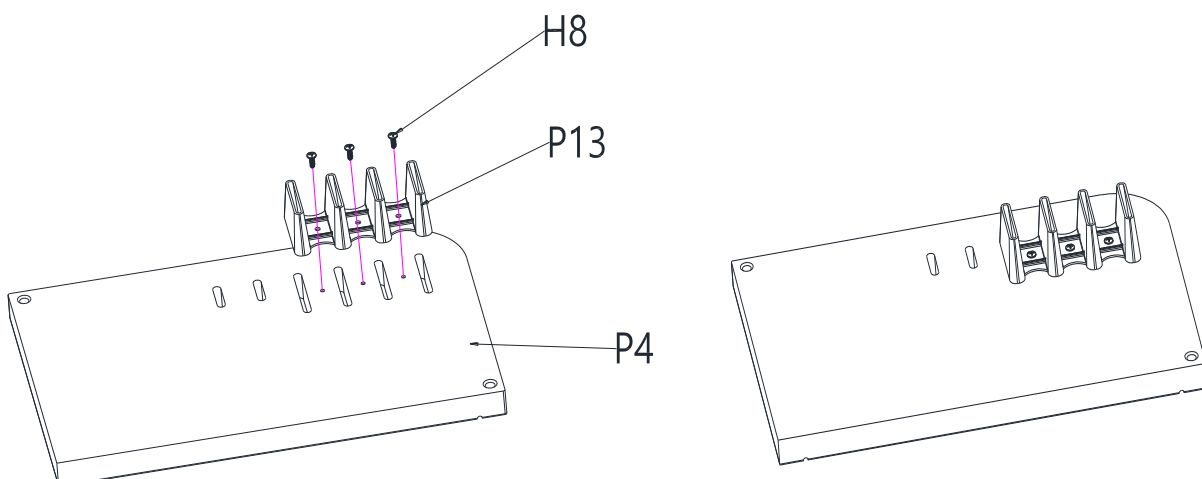

ASSEMBLY

Step 05

/Fix and fully tighten (H9 x 3) onto both sides at the top of main body (H10 x 3).

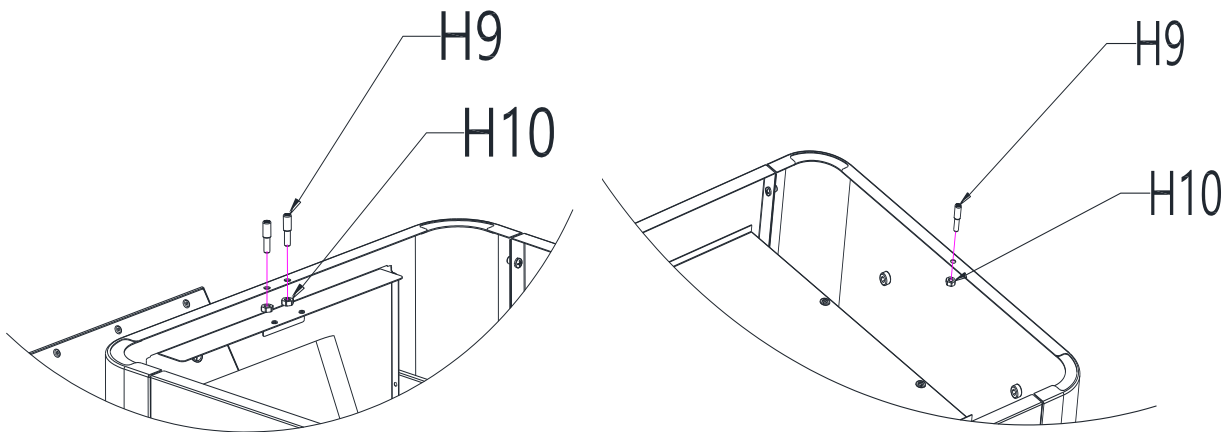

Step 06

/Place (P4 x 1, P5 x 1, P6 x 1, P7 x 1, P8 x 2, P9 x 3, P10 x 4) into position. See final image for reference

*Note, ignore this section if product arrived with parts pre-assembled

